

ACRYLIC PLASTIC FLOW METER

FBC SERIES

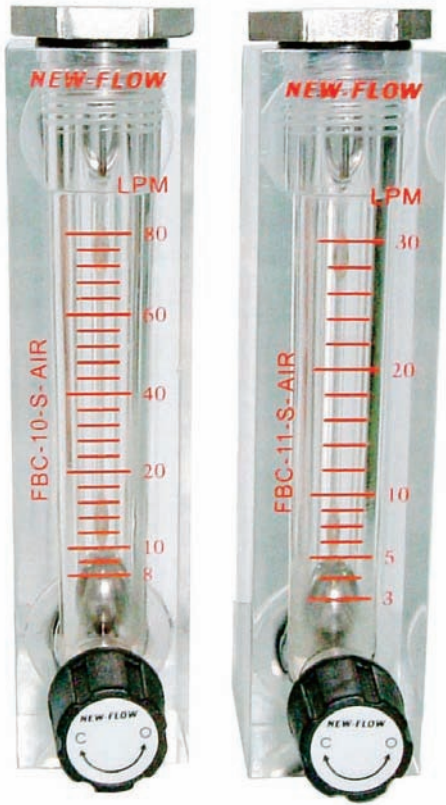

Technical Data

Service: gas & liquid

Wetted parts material: Body- Acrylic Plastic
O-ring- NBR (standard), Viton on request
Float- SS316, Glass, POM Plastic

Valve material: SS316

Connection material: SS316

Connection size: 1/8"NPT female

Temperature & pressure limits: 150 psig(10bar) @ 100°F(38°C)

Temperature limit: -24°C~+54°C

Accuracy: 3% full scale

Mounting: vertical position

Weight: 0.12 kg

Dimensions

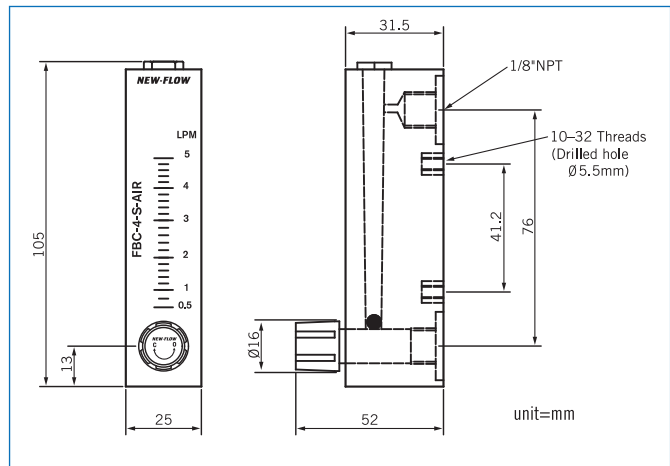

Range Table & Ordering Information

A. Fluid Type: Water

Item	Flow Range	Float Material	Flow Unit	Needle Valve	Ordering Code
1	5~50	SS316	cc/min, cc per Minute	with	FBC-V-S-W-50-C
				without	FBC-N-S-W-50-C
2	10~100	SS316	cc/min, cc per Minute	with	FBC-V-S-W-100-C
				without	FBC-N-S-W-100-C
3	25~250	SS316	cc/min, cc per Minute	with	FBC-V-S-W-250-C
				without	FBC-N-S-W-250-C
4	100~1000	SS316	cc/min, cc per Minute	with	FBC-V-S-W-1000-C
				without	FBC-N-S-W-1000-C
5	0.1~1	POM, Plastic	LPH, Litter per Hour	with	FBC-V-P-W-1-LH
				without	FBC-N-P-W-1-LH
6	0.5~5	SS316	LPH, Litter per Hour	with	FBC-V-S-W-5-LH
				without	FBC-N-S-W-5-LH
7	1.5~15	SS316	LPH, Litter per Hour	with	FBC-V-S-W-15-LH
				without	FBC-N-S-W-15-LH
8	3~30	SS316	LPH, Litter per Hour	with	FBC-V-S-W-30-LH
				without	FBC-N-S-W-30-LH
9	6~60	SS316	LPH, Litter per Hour	with	FBC-V-S-W-60-LH
				without	FBC-N-S-W-60-LH
10	10~100	SS316	LPH, Litter per Hour	with	FBC-V-S-W-100-LH
				without	FBC-N-S-W-100-LH
11	1.5~15	SS316	GPH, Gallon (us) per Hour	with	FBC-V-S-W-15-GH
				without	FBC-N-S-W-15-GH
12	2.5~25	SS316	GPH, Gallon (us) per Hour	with	FBC-V-S-W-25-GH
				without	FBC-N-S-W-25-GH

B. Fluid Type: Air

Item	Flow Range	Float Material	Flow Unit	Needle Valve	Ordering Code
1	60~300	POM, Plastic	cc/min, Normal cc per Minute	with	FBC-V-P-A-300-C
				without	FBC-N-P-A-300-C
2	80~450	Glass	cc/min, Normal cc per Minute	with	FBC-V-G-A-450-C
				without	FBC-N-G-A-450-C
3	100~1000	Glass	cc/min, Normal cc per Minute	with	FBC-V-G-A-1000-C
				without	FBC-N-G-A-1000-C
4	0.1~1	Glass	LPM, Normal Litter per Minute	with	FBC-V-G-A-1-LM
				without	FBC-N-G-A-1LM
5	0.2~2.0	SS316	LPM, Normal Litter per Minute	with	FBC-V-S-A-2-LM
				without	FBC-N-S-A-2-LM
6	0.5~5	SS316	LPM, Normal Litter per Minute	with	FBC-V-S-A-5-LM
				without	FBC-N-S-A-5-LM
7	1~10	SS316	LPM, Normal Litter per Minute	with	FBC-V-S-A-10-LM
				without	FBC-N-S-A-10-LM
8	2~20	POM, Plastic	LPM, Normal Litter per Minute	with	FBC-V-P-A-20-LM
				without	FBC-N-P-A-20-LM
9	2.5~25	SS316	LPM, Normal Litter per Minute	with	FBC-V-S-A-25-LM
				without	FBC-N-S-A-25-LM
10	4~40	SS316	LPM, Normal Litter per Minute	with	FBC-V-S-A-40-LM
				without	FBC-N-S-A-40-LM
11	5~50	SS316	LPM, Normal Litter per Minute	with	FBC-V-S-A-50-LM
				without	FBC-N-S-A-50-LM
12	8~80	SS316	LPM, Normal Litter per Minute	with	FBC-V-S-A-80-LM
				without	FBC-N-S-A-80-LM
13	10~100	SS316	LPM, Normal Litter per Minute	with	FBC-V-S-A-100-LM
				without	FBC-N-S-A-100-LM
14	10~100	SS316	LPH, Normal Litter per Hour	with	FBC-V-S-A-100-LH
				without	FBC-N-S-A-100-LH
15	20~200	POM, Plastic	LPH, Normal Litter per Hour	with	FBC-V-P-A-200-LH
				without	FBC-N-P-A-200-LH
16	30~300	SS316	LPH, Normal Litter per Hour	with	FBC-V-S-A-300-LH
				without	FBC-N-S-A-300-LH
17	50~500	SS316	LPH, Normal Litter per Hour	with	FBC-V-S-A-500-LH
				without	FBC-N-S-A-500-LH
18	60~600	SS316	LPH, Normal Litter per Hour	with	FBC-V-S-A-600-LH
				without	FBC-N-S-A-600-LH
19	80~800	SS316	LPH, Normal Litter per Hour	with	FBC-V-S-A-800-LH
				without	FBC-N-S-A-800-LH
20	0.15~1.5	SS316	NM ³ /H, Normal Cubic Meter per Hour	with	FBC-V-S-A-1.5-MH
				without	FBC-N-S-A-1.5-MH
21	0.3~3	SS316	NM ³ /H, Normal Cubic Meter per Hour	with	FBC-V-S-A-3-MH
				without	FBC-N-S-A-3-MH
22	0.6~6	SS316	NM ³ /H, Normal Cubic Meter per Hour	with	FBC-V-S-A-6-MH
				without	FBC-N-S-A-6-MH
23	0.3~3	SS316	SCFH, Standard Cubic Feet per Hour	with	FBC-V-S-A-3-SH
				without	FBC-N-S-A-3-SH
24	0.6~6	POM, Plastic	SCFH, Standard Cubic Feet per Hour	with	FBC-V-P-A-6-SH
				without	FBC-N-P-A-6-SH
25	1~10	POM, Plastic	SCFH, Standard Cubic Feet per Hour	with	FBC-V-P-A-10-SH
				without	FBC-N-P-A-10-SH
26	2~20	SS316	SCFH, Standard Cubic Feet per Hour	with	FBC-V-S-A-20-SH
				without	FBC-N-S-A-20-SH
27	5~50	SS316	SCFH, Standard Cubic Feet per Hour	with	FBC-V-S-A-50-SH
				without	FBC-N-S-A-50-SH
28	16~160	SS316	SCFH, Standard Cubic Feet per Hour	with	FBC-V-S-A-160-SH
				without	FBC-N-S-A-160-SH
29	20~200	SS316	SCFH, Standard Cubic Feet per Hour	with	FBC-V-S-A-200-SH
				without	FBC-N-S-A-200-SH

C. Fluid Type: Special Gas

Item	Flow Range	Float Material	Flow Unit	Needle Valve	Ordering Code
1	0.02~0.2	POM, Plastic	LPM, O ₂	with	FBC-V-P-A-0.2-LM
				without	FBC-N-P-A-0.2-LM
2	20~150	POM, Plastic	SCFH, NH ₃	with	FBC-V-P-A-150-SH
				without	FBC-N-P-A-150-SH